



HELIOSHADE[®]

AWNINGS RANGE



RELAXED / INDOOR
OUTDOOR / LIVING

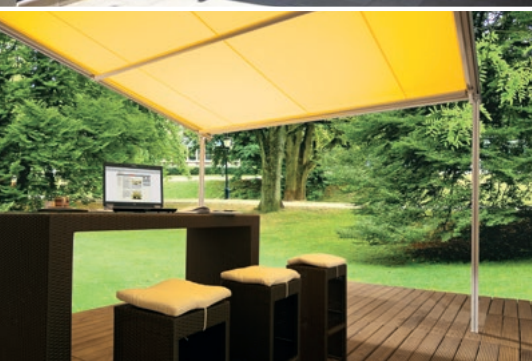



RUBIX CASSETTE

SEAMLESS INTEGRATION FOR MODERN ARCHITECTURE



The latest addition to the Helioscreen collection, the **Rubix Cassette** awning offers a premium shading solution with a focus on clean lines to suit the finest architecture. Designed to integrate seamlessly, the **Rubix Full Cassette** offers a streamlined architectural finish along with full protection to the system and fabric when not in use. Utilising the highest quality materials available including chromatised aluminium, Dulux powdercoating finishes, high grade stainless steel screws, along with

precision engineering and design down to the last detail, ensures long lasting durability and functionality for many years.

Tested and proven to well over 70,000 full cycles, the Multiflex 4-cable arm system is the strongest of it's kind on the market. With daily use this is more than a 200-year life span.

Ideally suited to our harsh Australian conditions, the arm system is optimised for long lasting tautness of the fabric under extended heavy use.

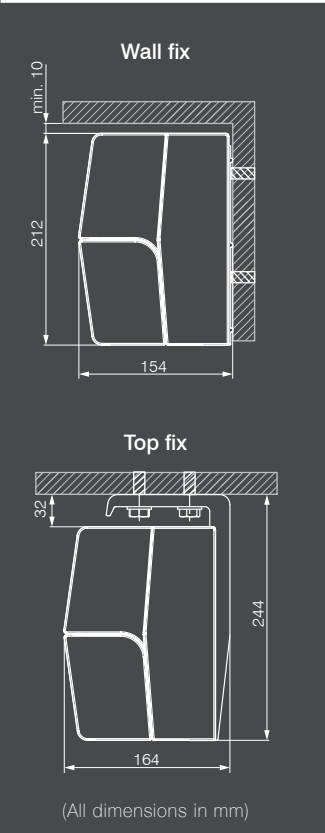

THE CASSETTE
The slimline **Rubix Cassette** with colour matched end caps in cast aluminium offers the perfect protection from the elements all with a size of just 154x212mm.

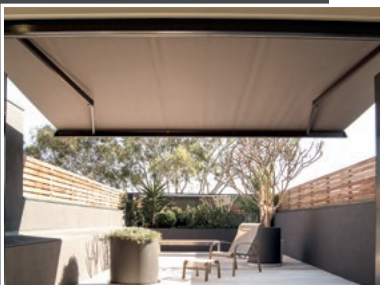

SPECIFICATION	SYSTEM DETAIL
Max width	6,000mm
Max projection	3,500mm
Installation angle	5-40°
Standard operation	Motor (gear unit & hand crank possible)
Fabric colours	Over 150 fabric colours
Standard frame colours	Over 120 Dulux & custom powdercoat colours
Premium frame colours	Over 50 Dulux Duratec & Electro commercial colours





COCOON CASSETTE

MINIMALIST DESIGN FOR CONTEMPORARY ARCHITECTURE

When modern architecture calls for slim and compact the **Cocoon Cassette** awning offers the ideal shading solution.

design down to the last detail, ensures long lasting durability and functionality for many years.

Designed for the minimalist, the **Cocoon Full Cassette** offers a slimline architectural finish along with full protection to the system and fabric when not in use. Utilising the highest quality materials available including chromatised aluminium, Dulux powdercoating finishes, high grade stainless steel screws, powercoated cast end caps, along with precision engineering and

Tested and proven to well over 70,000 full cycles, the Multiflex 4-cable arm system is the strongest of it's kind on the market. With daily use this is more than a 200 year life span.

Ideally suited to our harsh Australian conditions, the arm system is optimised for long lasting tautness of the fabric under extended heavy use.



Wall fix

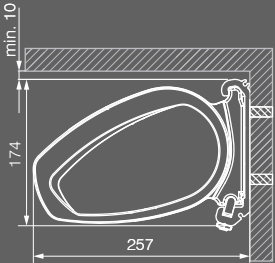

Top fix

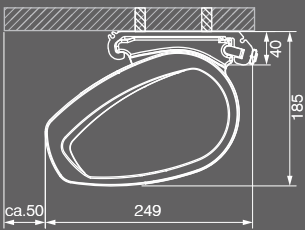

(All dimensions in mm)

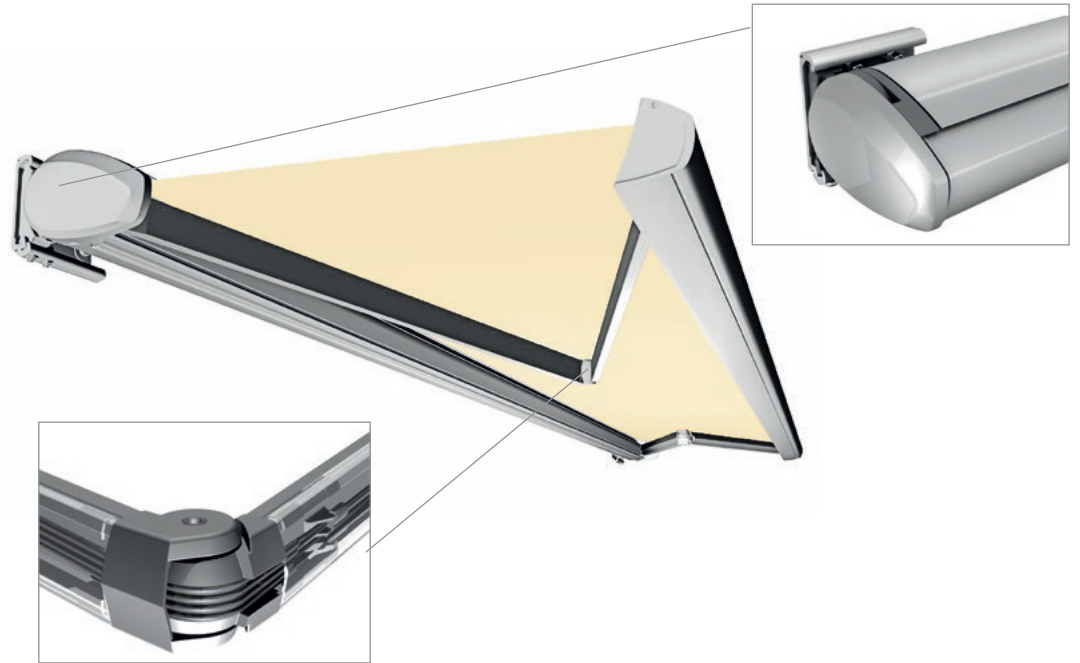

SPECIFICATION

SYSTEM DETAIL

Max width	5,500mm
Max projection	3,500mm
Installation angle	5-50°
Standard operation	Motor (hand gear possible)
Fabric colours	Over 150 fabric colours
Standard frame colours	Over 120 Dulux & custom powdercoat colours
Premium frame colours	Over 50 Dulux Duratec & Electro commercial colours

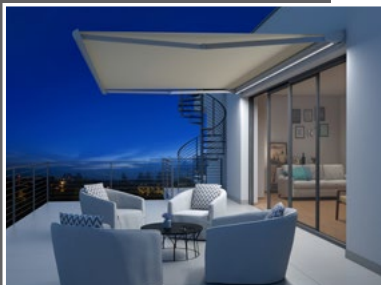

STRONG ARMS – THE HEART OF THE HELIOSCREEN AWNING RANGE

The Helioscreen range of awning arms are characterised by elegant, eye-catching design and convincing performance. All components have been developed to ensure smooth functioning and high durability, which have proven themselves in very demanding load tests. The use of high-quality aluminium profiles in combination with high-strength cast and drop-forged components stand for optimal

safety even under extreme load. The specially developed Multiflex power band is made up of four tear-resistant steel cables sheathed in a highly flexible plastic material protecting against corrosion. It applies the force of spring movements in the arm sections and ensures proper tensioning of the awning, whilst still allowing flexibility during gusts of wind.



CASSETTE

THE AWNING THAT MEETS THE HIGHEST DEMANDS

The **Cassette** is the superior model of the **Helioshade®** series from Helioscreen. Using innovative German technology and stylish Italian design, it perfectly protects the awning fabric and its working parts from the harsh Australian environment with a fully closing cassette. Top quality materials including chromatised

aluminium and marine grade stainless steel screws, along with precision engineering down to the last detail ensure perfect functionality and durability. High strength extruded brackets guarantee a sound fixing, even on difficult facades. The **Cassette** can be fully automated with a motion and wind sensors.

Wall fix

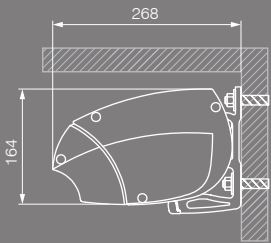

Top fix
(with optional Vario-valance)

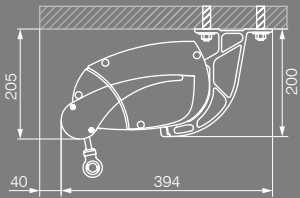

(All dimensions in mm)

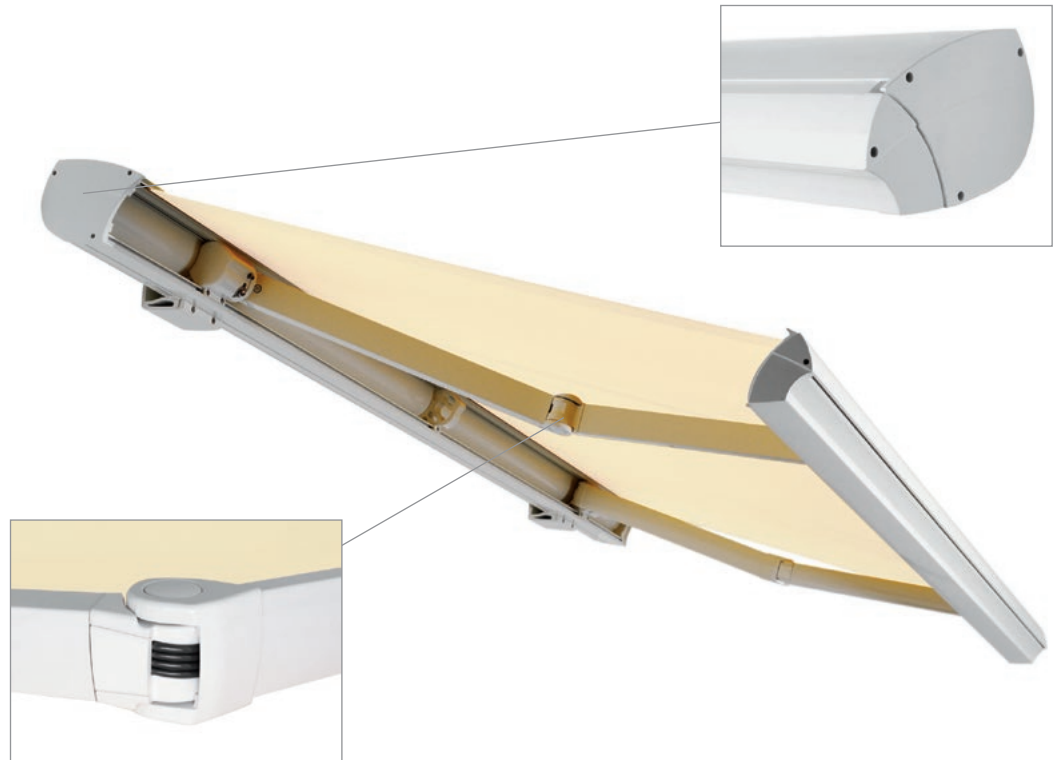
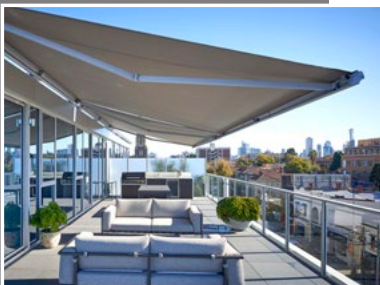

SPECIFICATION

SYSTEM DETAIL

Max width	8,000mm
Max projection	4,000mm
Installation angle	5-40°
Standard operation	Motor (gear unit & hand crank possible)
Fabric colours	Over 150 fabric colours
Standard frame colours	Over 120 Dulux & custom powdercoat colours
Premium frame colours	Over 50 Dulux Duratec & Electro commercial colours



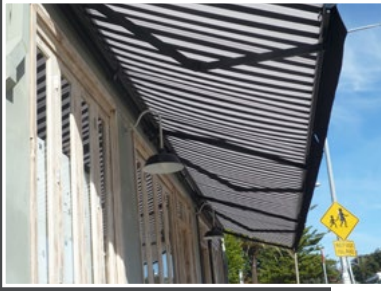

FABRIC-CASSETTE

FABRIC-CASSETTE AWNING

THE CUSTOM-MADE INTELLIGENT SUN CONTROL SOLUTION

An elegant and compact fabric-cassette awning, the **Fabric-Cassette** offers the fabric and motor full protection from the elements with its unique adjustable angle cassette. The fabric-cassette is mounted via a integrated torque bar with numerous mounting options making the **Fabric-Cassette** a universal awning suitable for a large range of applications. With the Vario valance the **Fabric-Cassette** is optimally

adaptable to any position of the sun. Thanks to the chromatising of all aluminium parts as well as screws and nuts made of marine grade stainless steel, the **Fabric-Cassette** awning is extremely resistant to corrosion. Extension of the awning is by means of a SOMFY motor which is backed by a 5 year warranty and also offers the option of automated sun, wind or rain sensors.

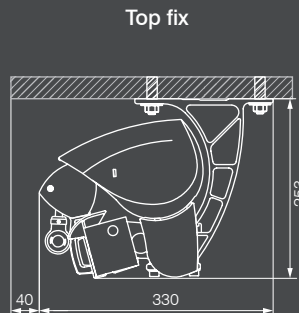
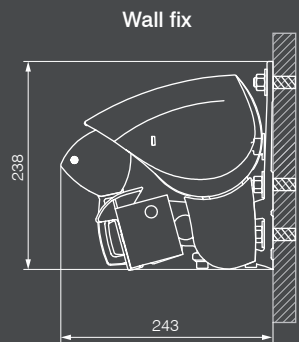

(All dimensions in mm)

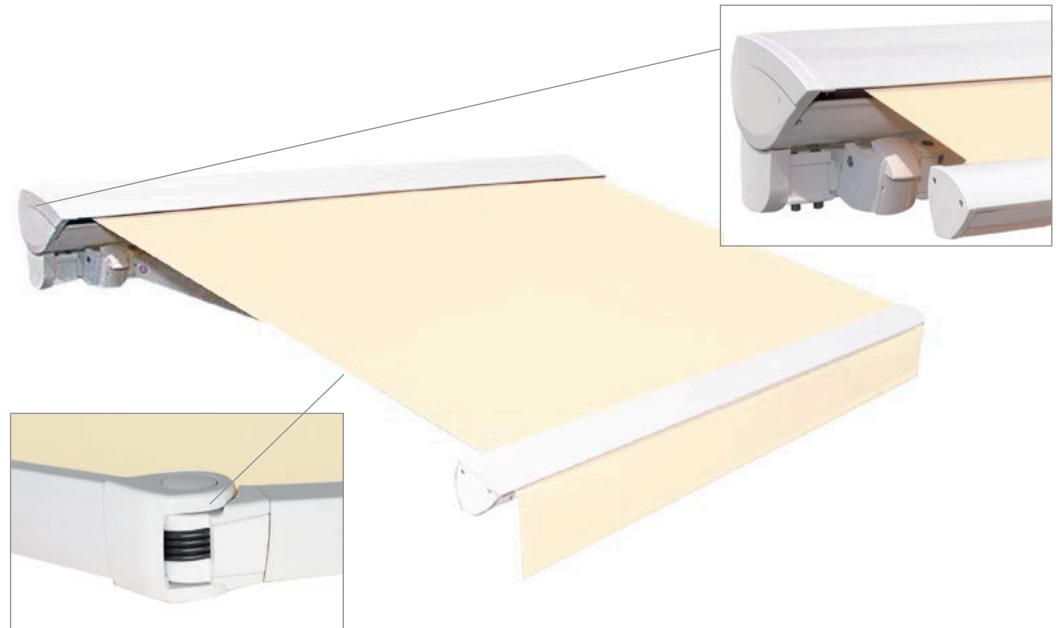

SPECIFICATION	SYSTEM DETAIL
Max width	8,000mm
Max projection	4,500mm (Only possible from 5 – 6.5m wide)
Installation angle	5-45°
Standard operation	motor (gear unit & hand crank possible)
Fabric colours	Over 150 fabric colours
Standard frame colours	Over 120 Dulux & custom powdercoat colours
Premium frame colours	Over 50 Dulux Duratec & Electro commercial colours

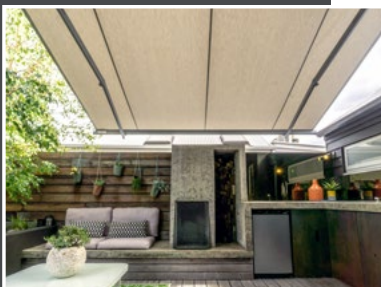

The Helioscreen team has a proven reputation for outstanding performance. Offering an extensive range of products with local support and next-generation solutions for over 30 years is why Helioscreen as a company is synonymous with quality and high-caliber service across Australia and New Zealand.

Using only the finest materials available from around the world, each component is selected to exceed expectations. When coupled with precision engineering, innovation and the latest

in advanced technology, Helioscreen awning systems have clearly proven to withstand the test of time.

Local assembly ensures precision results are made to order, and offers efficient turnaround times for production and after-market service. Production of our custom made textiles is done in-house with the latest innovative technology and we offer a choice of over 120 Dulux powdercoat colours at no extra charge. This guarantees the best aesthetic results for each system.



VARIO-PERGOLA

SELF-SUPPORTING SUNROOF

Where there is not an existing pergola or other structure for shading courtyards, decks, and outdoor living areas, you can create an outdoor room with this clever sun control solution. The **Vario-Pergola** self-supporting sunroof adds a new dimension to the Helioscreen outdoor living range.

The **Vario-Pergola** is suitable for a wide variety of applications and is more flexible than traditional conservatory or winter garden awning products. It can be installed using wall or ceiling brackets and doesn't require a

traditional substructure, as it supports itself on 60x60mm square front posts.

Lightweight but robust, the **Vario-Pergola** is based on the popular Varioscreen® system and comes with in-built water gutters on the side channels allowing outdoor areas to be utilised in light rain.

Available in Helio 92, Helio 86, or Helioshade 100 Fabric ranges, the **Vario-Pergola** is an attractive addition to any building and extends your outdoor living space – all year round.

Wall fix

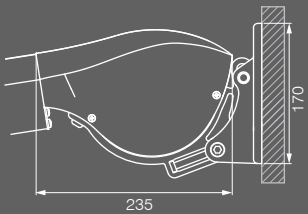

Top fix

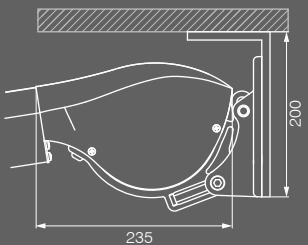

(All dimensions in mm)

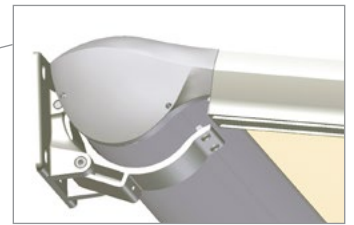
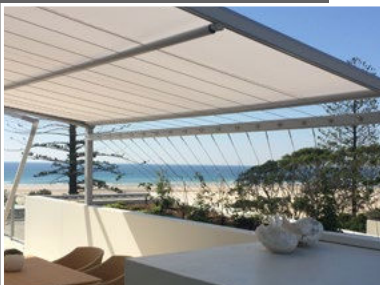

Wall bracket detail

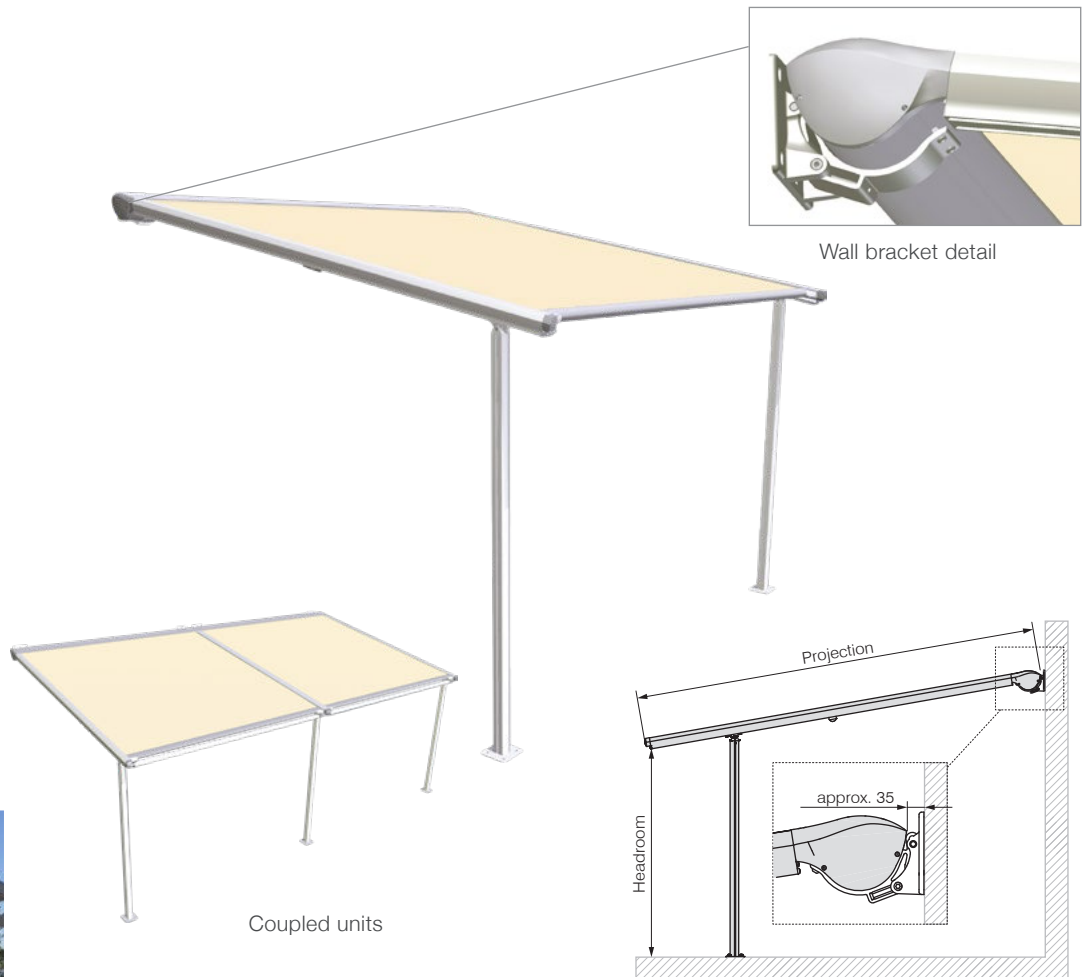

Coupled units

SPECIFICATION

SYSTEM DETAIL

Max width	6,000mm per unit
Max projection	6,000mm per unit
Max size	25sqm
Mounting	Tilt range 0-35°
Control	Handheld remote / App
Fabric colours	Over 150 fabric colours
Standard frame colours	Over 120 Dulux & custom powdercoat colours
Premium frame colours	Over 50 Dulux Duratec & Electro commercial colours